

# User Manual of Joystick Controller



---

## **Feature**

Optical 3D joystick gives you a more comfortable roll / pan/ zoom operation.

Camera control for camera menu operation

Use the unit button, you can quickly adjust the camera for a variety of automatic focusing, for example: a series of automatic focus adjustment, AE adjustment, a series of automatic white balance adjustment and brightness adjustment aperture.

VISCA protocol can be used to control up to 5 cameras, eliminating the need for a traditional keyboard control a cascade of trouble. And the camera can only be completed once the key switch, convenient and quick.

PTZ and lens control speed can be adjusted through the control knob

Each camera has 10 track memory

## The frontboard

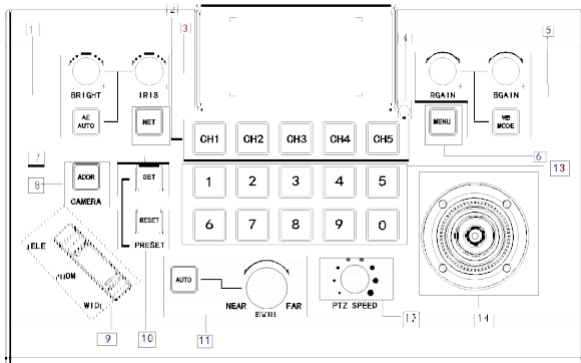

## Button function

- 1, "AE AUTO": Automatic Exposure Mode;  
"BRIGHT+": Bright adjustment  
"IRIS": Iris adjustment
- 2, "CHANNEL": Camera channel button (1-5)
- 3, Keyboard Display
- 4, Indicator light
- 5, White balance adjustment  
"WBC MODE": auto white balance mode selection;  
"+R Gain-" Red gain or less; "+B Gain-" Blue gain or less
- 6, "MENU": Call keyboard menu/Exit/Longpress to call camera menu
- 7, "SET"+"Number": Set presets
- 8, "ADDR": Select camera ID
- 9, "ZOOM": Focal length adjustment; "TELE": Zoom in; "WIDE": Zoom out
- 10, "RESET"+"Number": Delete presets
- 11, Focus mode selection: "AUTO": auto focus; "NEAR": manual focus mode close up  
"FAR": Manual focus mode far focus.
- 12, "PTZ SPEED": Camera pan/tilt speed adjustment
- 13, "POSITION" 1-0 number for setting, calling and deleting presets.
- 14, Control joystick: Select the camera you want to control  
Left/Right: Pan  
Pitch Up/Down: Tilt  
Rotate clockwise/Counterclockwise: Zoom in/Zoom out  
When you release the remote, the camera will stop moving.

## Backside

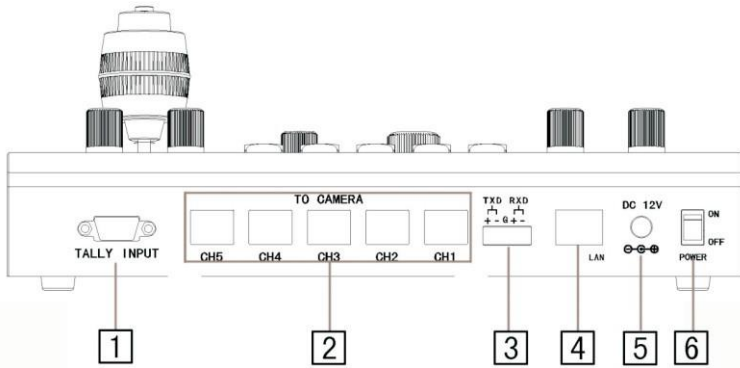

### Interface introduction

- 1、TALLY port
- 2、Camera controll channel(CH1-CH5)
- 3、RS422/485 control(use Ch1 control)
- 4、Ethernet port
- 5、12V DC power supply
- 6、Power switch

### Display Introduction

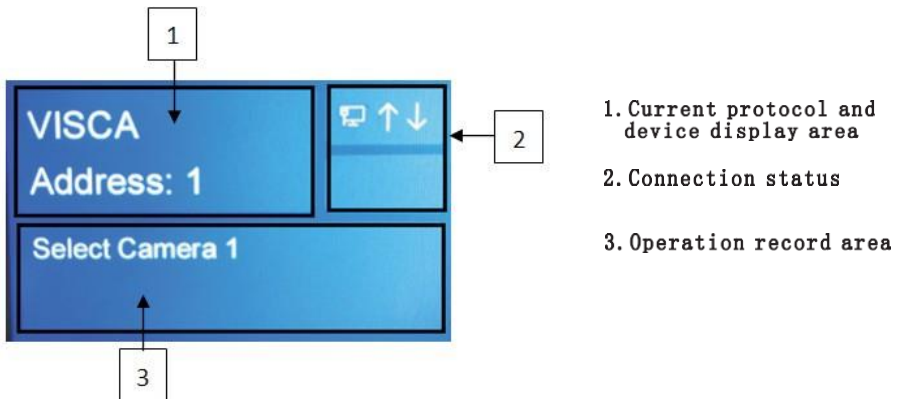

## OSD menu setting

Enter the keyboard settings menu:

- 1) Press the MENU key, light is on.
- 2) Keyboard factory default password is turned off, can enter the menu directly

Enter the menu, control the joystick up and down to switch the setting items. Control to the right, means confirmation. To the left, return to the previous level. Press "MENU" again to save the parameter and exit menu directly. Keyboard menu settings are as follows:

SETTING	
1. Select Protocol	>
2. Protocol setting	>
3. IP Shortcut	>
4. Ethernet	>
5. Serial Port	>
6. Rocker	>
7. Buzzer	OFF>
8. Sleep Time	Minute>
9. Language	English>
10. About Device	>
11. Reset Device	>

### NO.1: Camera protocol selecting

Method:

Use the joystick to move the cursor to "Select Protocol", move the joystick to the right to enter next menu. Enter different channels to select network control or serial mode control mode. The selected item will be marked with a hook.

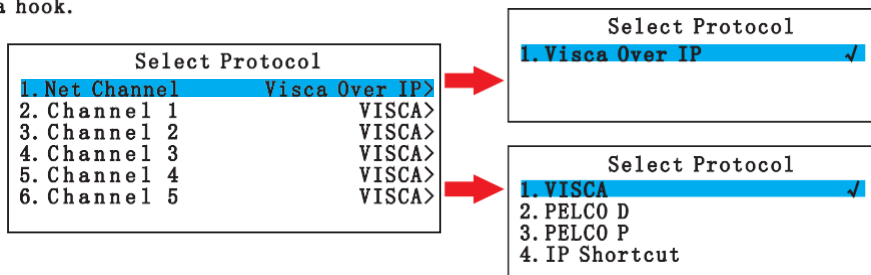

### NO. 2: Protocol setting

Method:

Use the joystick to move the cursor to "Protocol setting", move the joystick to the right to enter next menu. Select the protocol "Visca Over IP", confirm to the right. Enter "Manage Custom Address" to add custom camera address, choose brand/network address/control method/port, or delete custom camera;

The flow chart is as follows:

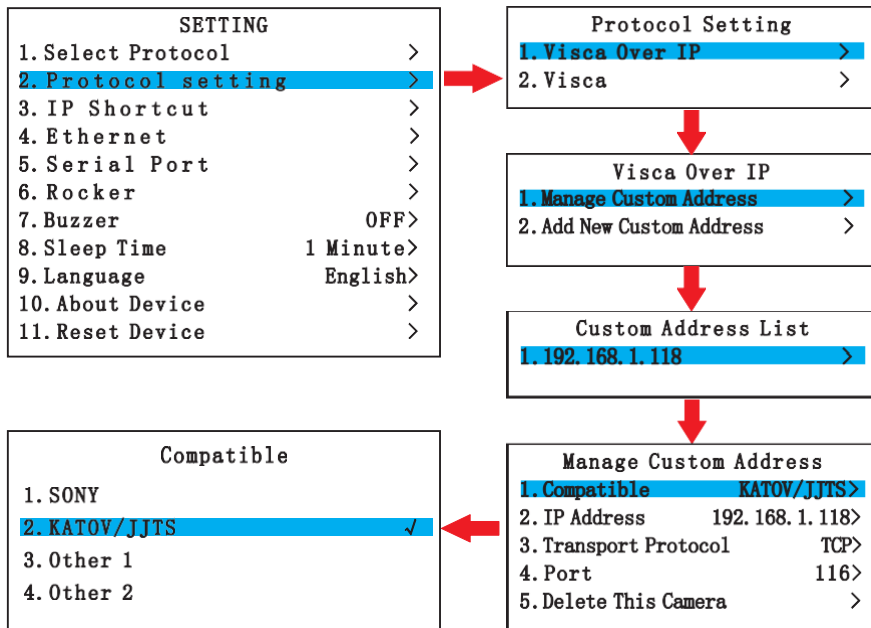

**Method:**

Use the joystick to move the cursor to “VISCA” protocol and move to the right to enter next menu. The joystick up and down selects the compatible camera manufacturer under the corresponding protocol; the flow chart is as follows:

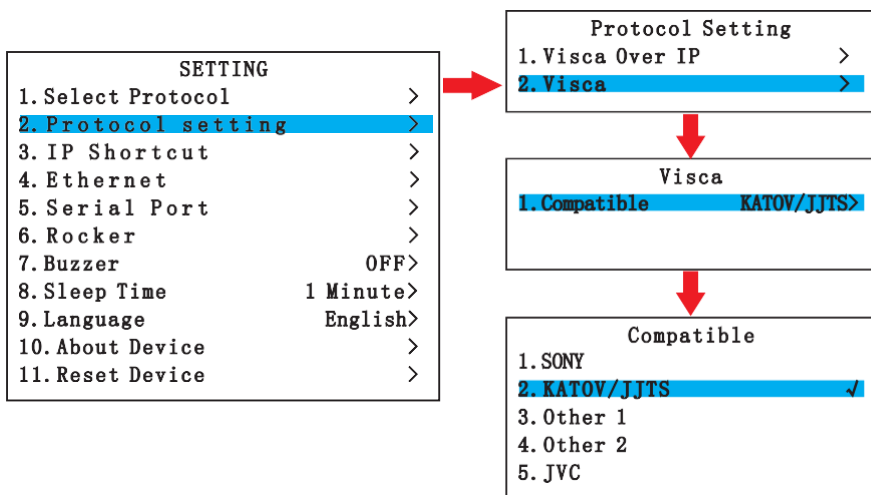

### No3: Switch network control mode

The operation method is as follows:

#### Methods:

Use the joystick to move the cursor up and down to “IP Shortcut”, and move the joystick to the right to enter next menu. The joystick up and down selects the corresponding channel to switch the network control mode, access the camera and network address; then enter the edit page to the right.

The flow chart is as follows:

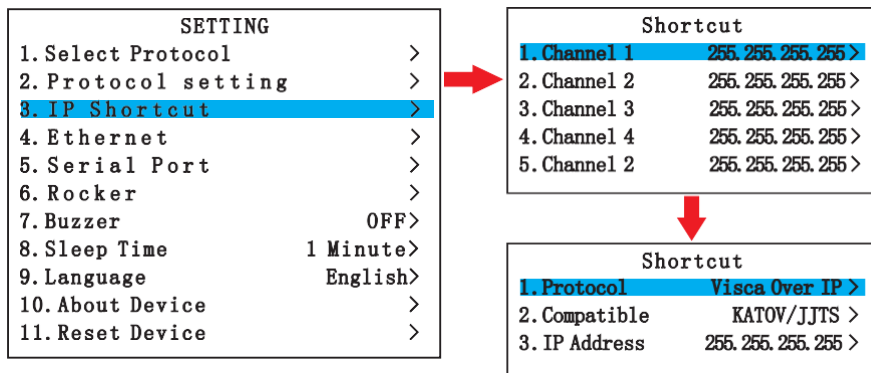

### No4: Keyboard network mode setting

#### Methods:

Use joystick to move the cursor up and down to “Ethernet”, move the joystick to the right to enter next menu. The joystick up and down selects “DHCP ON” (Obtain IP address automatically) and “DHCP OFF” (Fill the IP address manually).

The flow chart is as follows:

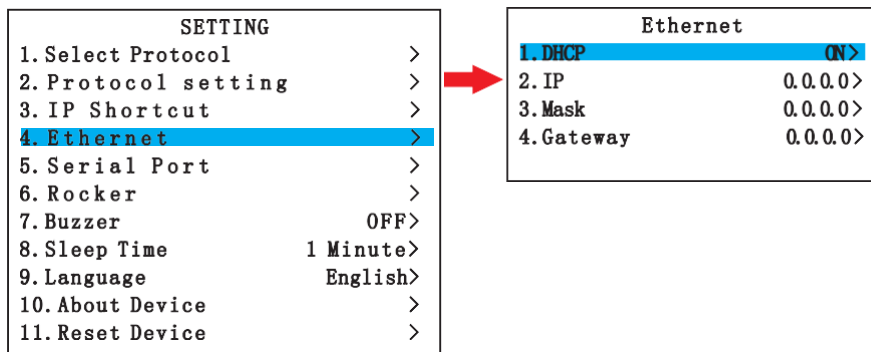

## No5: Serial port setting

### Methods:

Use the joystick to move the cursor to “Serial port” item, move the joystick to the right to next menu. Selects whether to enable instruction repeater function and set the mode, and then enters the editing interface again to the right. The flow chart is as follows:

The following picture: indicates the selected baud rate is 9600(2400-115200). Move the joystick to the right and save the parameter.

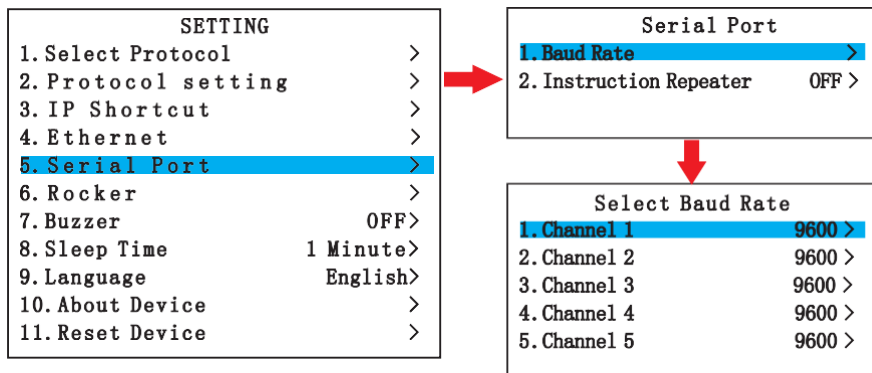

Note: If need to turn on the instruction repeater function, you need to choose it “ON”, enter the Instruction Repeater menu to open, and choose which way to control.

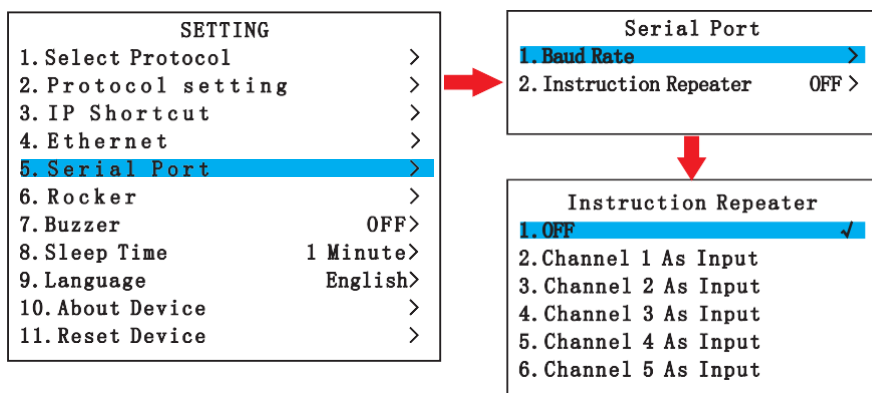



## No6: Pan and Tilt Reverse

### Methods:

Use the joystick to move the cursor to “Serial port” item, move the joystick to the right to next menu, then choose whether to turn on “PAN Reverse” or “TILT Reverse”. Choose “OFF” or “ON” after selecting.

“Rocker Switch Correct” is for resetting the Zoom Rocker, which prevents the error of Zoom Rocker hardware.

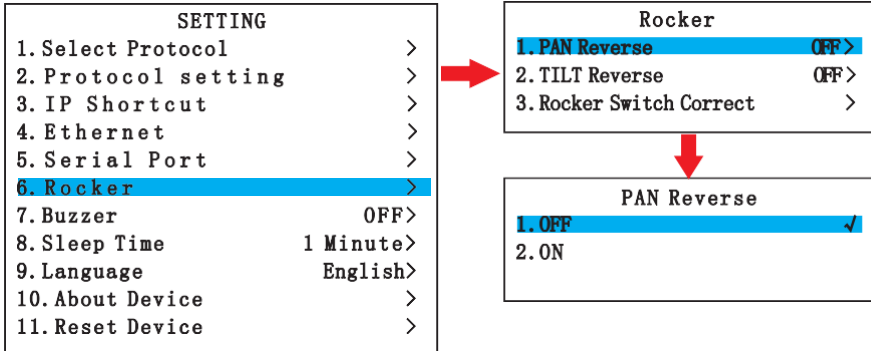

## No7: Buzzer

### Methods:

Use the joystick to move the cursor to “Buzzer” item, move the joystick to the right, and select the button buzzer switch (OFF/ ON). The picture below shows the button beep switch is off.

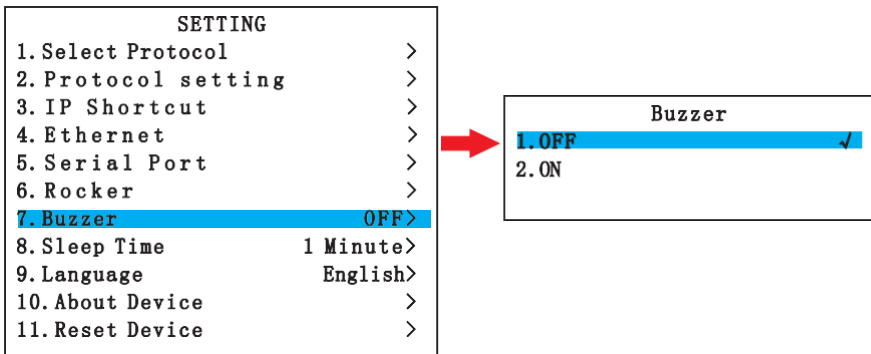

#### No8: Time setting of LCD screen

##### Methods:

Use the joystick to move the cursor to “Sleep Time” item, move to the right to enter next menu. Then choose the sleep time or “NO Sleep”, The flow chart is as follows:

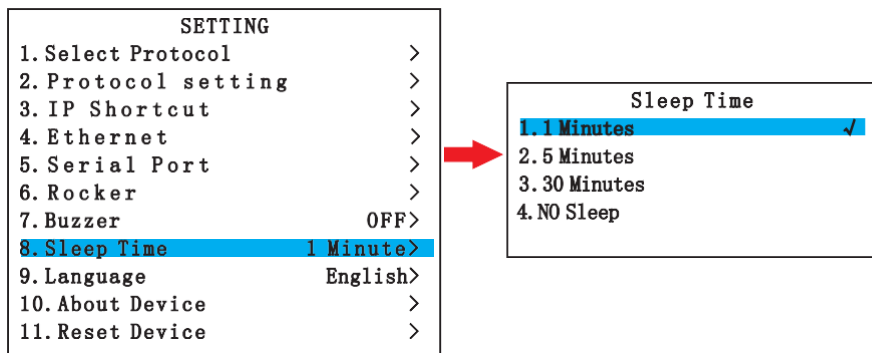

#### No9: Language

##### Methods:

Use the joystick to move the cursor to “Language”, move to the right to choose language. The flow chart is as follows:

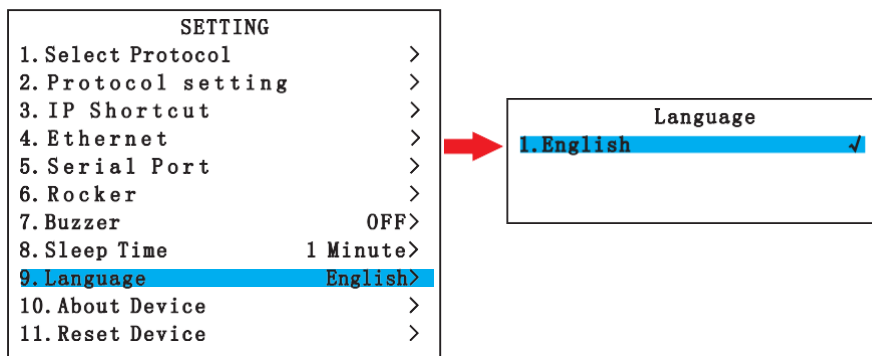

## No10: About Version

### Methods:

Use the joystick to move the cursor to “About Device”, move the joystick to the right to enter next menu, then check the version and release time.

The flow chart is as follows:

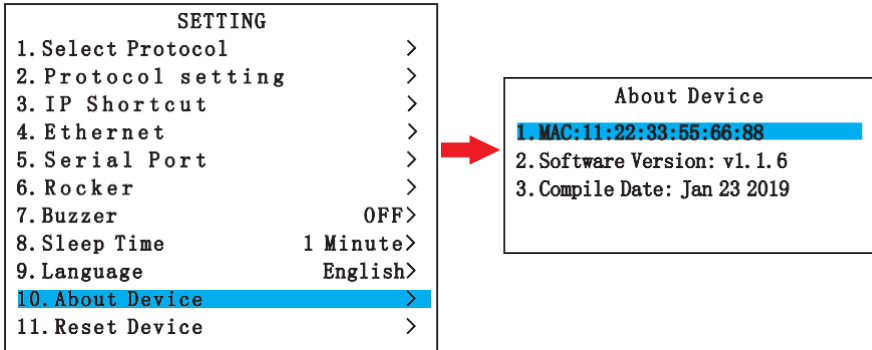

## No11: Reset Device

### Methods:

Use the joystick to move the cursor to “Reset Device”, move the joystick to the right to enter next menu. Choose whether to reset factory setting.

## Installation Before Using

1. The equipment comes with a 12V DC power supply, one RS232 line, one network cable. Plug in the power as required, turn on the power switch, and the LCD screen is displayed:



## Equipment installation before use

### 2.Camera connect

If the camera distance is within 100 meters, the NET connection can be adopted.

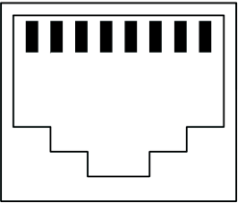
Schematic Diagram	Functions
 <p>LAN</p>	<ol style="list-style-type: none"><li>1. TX+</li><li>2. TX-</li><li>3. RX+</li><li>4. TERM</li><li>5. TERM</li><li>6. RX-</li><li>7. TERM</li><li>8. TERM</li></ol>

If the camera is close to the keyboard (less than 20 meters), can adopt RS232 connection. The equipment provides a 1-meter-RS232 cable.

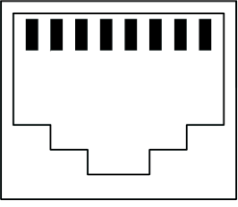
Schematic Diagram	Functions
 <p>CH1-CH5</p>	<ol style="list-style-type: none"><li>1. RS485 A+</li><li>2. RS485 B-</li><li>3. RS232-TX</li><li>4. GND</li><li>5. GND</li><li>6. RS232-RX</li><li>7. GND</li><li>8. GND</li></ol>

If the length of the standard cable is not long enough, it can be cut and added to a three-core cable of appropriate length. (Note do not make it wrong and the welding method is adopted to ensure good contact).

Then plug the cable into the COM port of the keyboard and the other end into RS232 IN of the camera.

The DB9 port pin definition diagram and wire line sequence diagram are as follows:

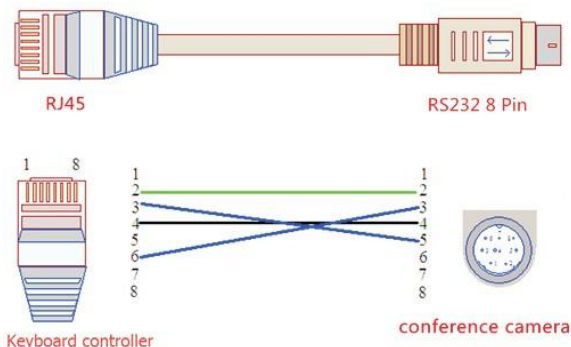

If the camera is far from the keyboard (more than 20 meters), can adopt RS422/485 connection.

The following picture shows the RS422 wiring of the SONY EVI-D70 camera and K1:

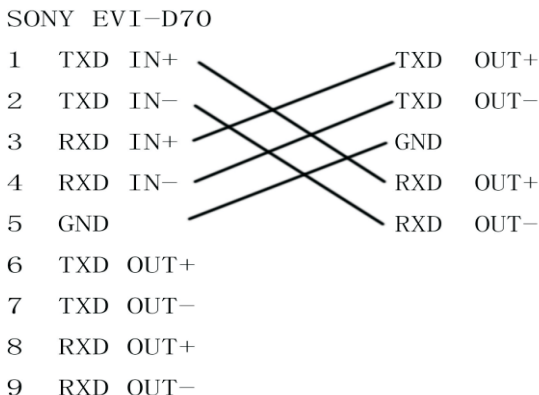

The following picture shows the RS485 wiring diagram of KT-HD61C camera and K1:

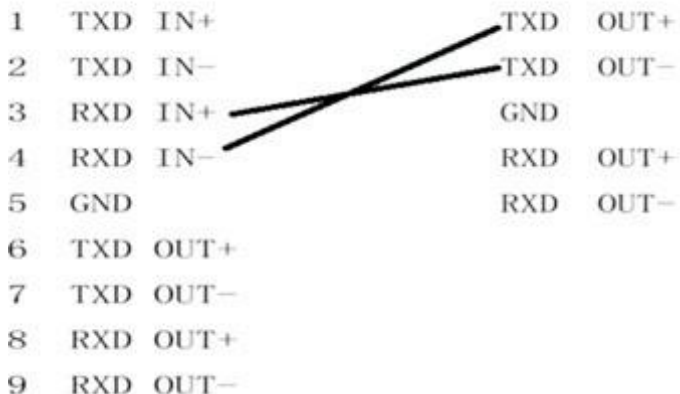

## Keyboard Instructions

### 1. Power on

Plug in the power supply and turn on the power switch. If the keyboard isn't connected to the camera, the keyboard display as followed:

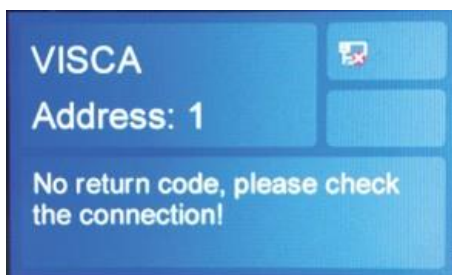

If the camera is connected and the keyboard is powered on for the first time, the default control channel is CH1, and the default control camera is 1. The display shows:



---

The keyboard will save the signal channel selection after power-off restart.

Take the LAN interface as an example. When the NET channel is selected, the last operation will be automatically restored after the power-off restart.

The keyboard display is as follows:



## 2.Camera select

Single control mode (One camera controlled by per channel)

Choose the channel from "CH1-CH5" buttons. For example, press the "CH3" button, then the "CH3" button will remain red, indicating the camera with address "1" of "CH3" channel is controlled. All operations are performed on this camera.

Press "CH1" to select the control channel as CH1, press the "ADDR" button (the ADDR button will remain red when selecting camera), start camera selection. Select the digital area (1-0) and input "2", then select to control the camera with address 2, showing controlling camera 2 in channel 1.

After exiting the camera selection, all operations are performed on this camera.



## 3.Control the joystick operation

The control joystick located in the lower right corner is a control component that quickly rotates the camera and its lens, has three-dimensional control functions of turning left and right, up and down. Camera turns to the left when joystick rotates to left, camera rotates upward when joystick is up, the pan/tilt speed is adjusted by the "PTZ SPEED" knob.

When rotating the joystick, can control the camera lens Lens expansion. The speed of viewing far and close-up can be controlled by "PTZ SPEED".

#### 4.Preset setting

The preset position is an operation of pointing the camera lens at a specific location in advance. After setting the preset position, when operator calls the preset number, the camera will turn to object location quickly.

The operation is as follows:

First operate the joystick to align the lens to the position, press the "SET" button (will remain red when setting preset positions).

Press number 1 of the number area(1-0) , then complete the preset number 1 setting. The keyboard display is as follows:



Operate the joystick to a second point, and enter different numbers in sequence. Note that the operator needs to remember the preset positions and numbers.

10 preset positions can be set for each camera through this keyboard. The preset number of each camera is from No. 1 to No. 0.

#### 5.Call preset

When the three buttons "ADDR", "SET" and "RESET" are all off, the number area (1-0) is in calling preset mode.

Select number 1, then call the preset 1.

The keyboard display is as follows:





---

## 6.Delete preset

Press the “Reset” button (will remain red when deleting preset positions).

Select number 1, then delete the preset 1.

The keyboard display is as follows:



## 7.Exposure mode selection

Press “AE AUTO” button to trigger auto exposure mode;

Rotate the “BRIGHT” knob that triggers the brightness priority, which can adjust the brightness of the camera, “+” to increase the brightness, “-” to reduce the brightness;

Rotate the “IRIS” knob that triggers the aperture priority, which can adjust the aperture of the camera, “+”, and “-” to reduce the aperture.

## 8.White balance mode selection

Press the “WBC MODE” button to cycle the white balance modes ( “Auto White Balance” , “Indoor” , “Outdoor” , “One push” , “ATW” , “Manual White Balance” );

Rotate the “RGAIN” knob that triggers the manual white balance mode, which can adjust the depth of red, “+” the red becomes darker, and the “-” becomes lighter;

Rotate the “BGAIN” knob that triggers the manual white balance mode, which can adjust the depth of blue, “+” the blue becomes darker, and the “-” becomes lighter.

## 9. The camera menu call

Press “MENU” button for about 2 seconds to call the camera menu.

Use the joystick to switch the item up and down, press the button on the joystick to confirm. Press the “MENU” for 2 second again to exit and save the modified item.

## 10.Camera pan-tilt speed adjustment

Rotate the “PTZ SPEED” knob to adjust the joystick to control camera pan, tilt, and zoom speed.

According to the point on the keyboard logo, small point direction of slow speed, the speed of the speed of large dots.

---

11. "Zoom" button to use

Press "ZOOM" button "TELE" to control the lens focal length.

Press the "ZOOM" button "WIDE" to control the short focal length of the lens.

12. Manual, automatic focusing

Rotate the "FOCUS" button to trigger the manual focus mode, and turn to the "NEAR" side to control the camera lens focus to close, rotate the "FAR" end to control the camera lens focus;

Press "AUTO" button to trigger auto focus